

# PRODUCT CATALOGUE

**POOL & SPA  
EQUIPMENT**

**POOL & SPA  
CHEMICALS**





## WE ARE NZ'S LEADING SUPPLIER IN THE INDUSTRY OF POOL AND SPA CHEMICALS, EQUIPMENT & TECHNOLOGIES.

We specialise in the manufacturing, importing and distribution of quality, value added pool and spa chemicals and equipment. With over 40 years of experience in the industry, we have created reputable brands and products found in pool and spa shops and larger FMCG stores nationwide. We are proud to be New Zealand's leading supplier in the industry.



### **Industry Experts**

Over 40 years of experience in chemical manufacturing and distribution. We are the best at what we do.



### **Reputable Brands**

We distribute only the most reputable brands in the pool and spa industry, from chemicals to equipment.



### **Service and Support**

Customer satisfaction is at the heart of what we do. We see every customer as a key partner.

## CONTACT US

### **North Island**

**Viviane Walker** 021 811 992  
viviane.walker@spaceindustries.co.nz

**Gary Mcleod** 027 473 4486  
gary.mcleod@spaceindustries.co.nz

**Peter Kruse** 027 478 8060  
peter.kruse@spaceindustries.co.nz

### **South Island**

**Warren Jones** 027 464 9110  
warren.jones@spaceindustries.co.nz

### **Customer Service**

**Dianne Eldialde**  
reception@spaceindustries.co.nz

### **Head Office**

160 Plunket Ave, Manukau  
Auckland 2104

**09 262 3902**  
[www.spaceindustries.co.nz](http://www.spaceindustries.co.nz)



Space Industries is a proud subsidiary of  
TCL Hunt and is a member of the  
Ravago Group



INDEX

# TABLE OF CONTENTS



**02**

**POOL & SPA  
EQUIPMENT**

**03**

**ROBOTIC POOL  
CLEANERS**

**06**

**POOL & SPA  
HEAT PUMPS**

**15**

**SALT  
CHLORINATORS**

**21**

**POOL & SPA  
PUMPS**

**31**

**SAND FILTERS &  
COMBO KITS**

**35**

**POOL VACUUM  
CLEANERS**

**38**

**CONSUMABLES**

**44**

**POOL & SPA  
CHEMICALS**

**45**

**BALANCE  
CHEMICALS**

**48**

**ALGAECIDE  
CHEMICALS**

**51**

**SANITISER  
CHEMICALS**

**57**

**SPECIALTY  
PRODUCTS**

**64**

**WATER TESTING  
SOLUTIONS**



# POOL AND SPA EQUIPMENT



# ROBOTIC POOL CLEANERS





## BWT COSMY BOT ROBOTIC POOL CLEANER AVAILABLE IN

MODEL	PRODUCT CODE
100	BWTC100
150	BWTC150
250	BWTC250

### PRODUCT OVERVIEW

- Lightweight and compact design—only 5.7KG.
- 15m<sup>3</sup>/h suction flow and 3 motors in 1 for a powerful cleaning experience.
- COSMY 100 cleans pool floors, COSMY 150-250 cleans floors, wall and waterline.
- COSMY 250 is compatible with the BWT app for full control via smartphone.  
Customisable with 7 available colour sets and 1 extra colour set comes with purchase.

### TECHNICAL PARAMETERS

			
	BOT 100	BOT 150	BOT 250
<b>SPECIFICATIONS</b>			
Weight	5.7kg	5.7kg	5.7kg
Power supply	< 29 Volt	< 29 Volt	< 29 Volt + App
Power consumption	< 150 Watt	< 150 Watt	< 150 Watt
<b>EQUIPMENT</b>			
Filter type	Single layer filtration	Single layer filtration	Dual layer filtration
Filter access	Top access Full filter indicator	Top access Full filter indicator	Top access Full filter indicator
Brush type	PVC brushes	PVC brushes	PVC brushes
Cable Length	12m	16m	18m
<b>CLEANING</b>			
Pool size	Up to 8m	Up to 10m	Up to 12m
Pool shape	All shapes & finishes	All shapes & finishes	All shapes & finishes
Cleaning type	Floor	Floor, walls & water line	Floor, walls & water line
Cleaning cycle durat	1.5 hours	2 hours	1.5, 2 or 2.5 hours
Smart phone APP	No	No	Yes
Storage accessory	Optional	Optional	Premium caddy
Navigation technology	Smart navigation Gyroscope Beach entry detection	Smart navigation Gyroscope Beach entry detection	Smart navigation Gyroscope Beach entry detection

### 7 COLOUR SETS AVAILABLE





## WYBOTICS OSPREY 200 CORDLESS ROBOTIC POOL CLEANER

**PRODUCT  
CODE  
WYBOT1102**

### PRODUCT OVERVIEW

A functional, everyday cordless robotic pool cleaner suitable for most small to medium sized above ground pools up to 2m depth. Weighing in at a light 3.6 kg, the Osprey 200 is perfect for a quick clean up. Simply charge the robot (with a full charging time of 3-4 hours) and let it run at its running capacity of up to 50 minutes. It features a reliable filter capability of up to 120L/min, ensuring that particles and dirt are caught. Easy to store for future use and a great all around robot.

### TECHNICAL PARAMETERS

Osprey 200			
Filter density	180µ	Dimensions (l x w x h)	34 x 35 x 33 cm
Filter capability	120L/min	Charging time	3-4 hours
Moving speed	16m/min	Power	30 watt
Water depth	2.5m	Working voltage	11V
Cleaning cycle	50 mins	Adapter input voltage	100Vac-240Vac
Cleaning type	Floor	Adapter output voltage	12.6Vdc
Cleaning surface	50m <sup>2</sup>	Weight	3.6 kg



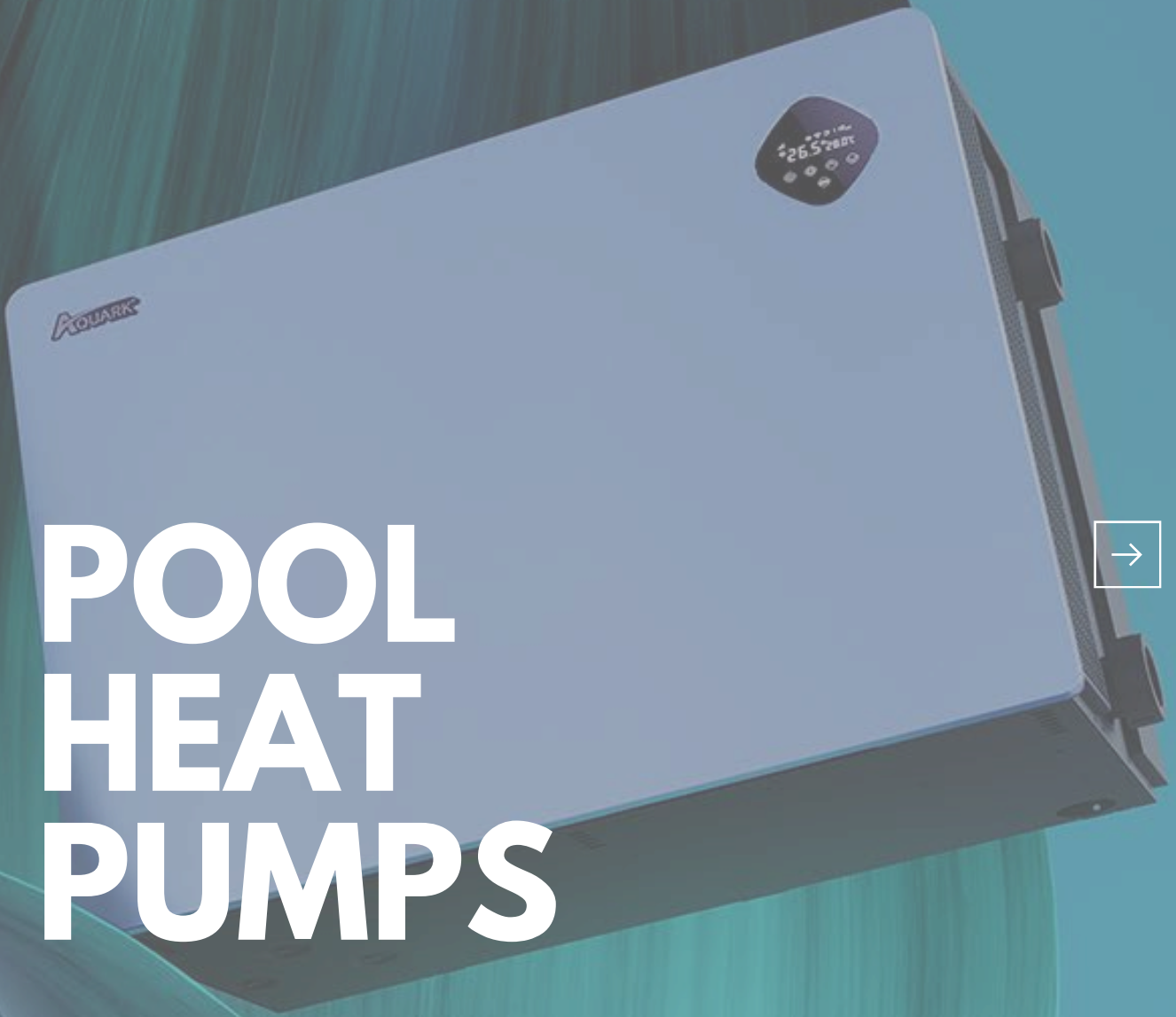

# POOL HEAT PUMPS



# THERE IS NO PERFECT POOL HEAT PUMP, UNTIL NOW.



- Silent
- Energy efficient
- Simple operation
- Built-in wifi



---

## INTRODUCING THE AQUARK MR. PERFECT

Featuring state of the art  
InverPad® turbo technology,  
utilising the most advanced silent  
technology in Turbofan.

**AQUARK**<sup>®</sup>  
iOutdoor Living



# MR. PERFECT

Perfect Silence

20 times silent as low as

**38.4**  
dB(A)

0 Mechanical Noise



## ADVANCED CONTROLLER

The improved controller provides simple operation with advanced data monitoring. It also combines full panel tempered glass and responsive back lighting for a highly sophisticated appearance.



## ANYWHERE ANYTIME

Control your heat pump anywhere and anytime with **InverGo**.



Controller in your hands  
Enjoy and access all the features of your heat pump controller

Set Schedules

Share with your loved ones



# AQUARK MR. PERFECT POOL HEAT PUMP

AVAILABLE IN

KW	PRODUCT CODE
17KW	QAHPMP170
22KW	QAHPMP220

## PRODUCT OVERVIEW

Introducing the Aquark Mr. Perfect, **the most silent pool heat pump** on the market, featuring its patented INVERPAD® TURBO technology, ensuring the unit runs at a pin drop 38.4 db(A). With a state-of-the-art control system, it provides **simple, seamless operation** with advanced data monitoring. Up to **69% more energy efficient** than traditional pool heat pumps. Easy to control through built-in wifi and your smartphone via the **InverGo** app. Available on the Apple App Store and Android Google Play.

### Comprehensive Warranty

Compressor & heat exchange - 10 years replacement including labour.  
Other parts - 5 years parts and labour plus additional 3 years parts only.  
See terms & conditions for further information.

## TECHNICAL PARAMETERS

Model	MP170/17kW	MP220/22kW
Advised Pool Volume (m <sup>3</sup> )	<35-65	40-80
Air 27°C/Water 27°C/Humidity 80°C		
Power/Turbo Mode		
Heating Capacity (kW)	17	22.5
Perfect Mode		
Heating Capacity (kW)	13.4	18
COP	15.0-7.1	15.5-7.4
Average COP at 50% speed	11.1	11.8
Air 15°C/Water 26°C/Humidity 70°C		
Power/Turbo Mode		
Heating Capacity (kW)	11.5	15
Perfect Mode		
Heating Capacity (kW)	9.2	12.6
COP	7.8-5.0	8.2-5.1
Average COP at 50% speed	6.5	7
Technical Specifications		
Compressor	Twin Rotary DC	Twin Rotary DC
Fan Motor	Turbo Fan	Turbo Fan
Casing	Aluminium-alloy casing	Aluminium-alloy casing
Power Supply	230V	230V
Rated input power (kW)	0.36-2.67	0.45-3.33
Input power at 50% speed (kW)	0.71	0.9
Rated input current (A)	1.57-11.63	1.96-14.48
Sound level @ 1m db(A)	39.3-46.7	39.5-49.8
Sound level 50% @ 1m db(A)	42.2	43
Advised water flux (m <sup>3</sup> /h)	4 to 6	6 to 9
Water connection (mm)	50	50



DC twin-rotary Inverter compressor of Mitsubishi



EEV technology: 10 times flexibility to adjust the gas flow and increase COP by up to 20%.



32% GWP comparing to R410A  
25% CO2 carbon consumption  
25% quota cost



Hot gas defrosting with Saginomiya 4 way valve for quick and efficient defrosting.



Twisted titanium heat exchanger: 40% higher efficiency than normal titanium heat exchanger.



Operate in air temp down to -15°C

# BWT HPF PEARL INVERTER POOL HEAT PUMP

AVAILABLE IN



<i>KW</i>	<i>PRODUCT CODE</i>
<b>9KW</b>	<b>BWTHPF09</b>
<b>13KW</b>	<b>BWTHPF13</b>
<b>16KW</b>	<b>BWTHPF16</b>
<b>20KW</b>	<b>BWTHPF20</b>
<b>24KW</b>	<b>BWTHPF24</b>
<b>28KW</b>	<b>BWTHPF28</b>

## PRODUCT OVERVIEW

The most intuitive, intelligent and efficient pool heat pump on the market.

- Simple and intuitive operation and optimal performance.
- Built in connection with BWT Pearl Connect app (available on App Store / Play Store) for smart phone management and control.
- Low noise levels.
- Energy efficient in 3 operating modes; max, eco, silent.

## Comprehensive Warranty

3 year initial product warranty + 2 years if the product is registered to PolyConnect.  
See terms and conditions for further information.

## TECHNICAL PARAMETERS

MODELS	BWT PEARL HPF09	BWT PEARL HPF13	BWT PEARL HPF16	BWT PEARL HPF20	BWT PEARL HPF24	BWT PEARL HPF28
Pool size guide	30-45m <sup>3</sup>	55-70m <sup>3</sup>	70-85m <sup>3</sup>	85-105m <sup>3</sup>	105-130m <sup>3</sup>	130-160m <sup>3</sup>
Air 28°C / Water 28°C / 80% HR						
Capacity in MAX Mode	9,3 kW	13,1 kW	16,1 kW	20,4 kW	24,2 kW	27,8 kW
COP MAX Mode	6,5 - 5,5	5,6	5,1	5,2	5,4	5,2
Capacity in ECO Mode	8,8 - 3,5 kW	13,1 - 4,2 kW	16,1 kW - 5,5 kW	20,4 - 6,5 kW	24,2 - 7,8 kW	27,8 - 10,5 kW
COP ECO Mode	10,8 - 5,5	11,2 - 5,6	10,8 - 5,1	10,1 - 5,2	10,8 - 5,4	10,1 - 5,2
Capacity in SILENT Mode	5,8 - 3,5 kW	4,2 kW	5,5 kW	6,5 kW	7,8 kW	10,5 kW
COP SILENT Mode	10,8 - 8,3	11,2	10,8	10,1	10,8	10,1
Air 15°C / Water 26°C / 70% HR						
Capacity in MAX Mode	6,6 kW	9,8 kW	11,5 kW	14,8 kW	18,2 kW	22,8 kW
COP MAX Mode	5,3	4,7	4,4	4,5	4,4	4,2
Capacity in ECO Mode	6,6 - 3,2 kW	9,8 - 3,7 kW	11,5 - 4,2 kW	14,8 - 4,9 kW	18,2 - 6,8 kW	22,8 - 8,1 kW
COP ECO Mode	6,7 - 5,6	7,0 - 4,7	6,7 - 4,4	6,6 - 4,5	6,7 - 4,4	6,5 - 4,2
Capacity in SILENT Mode	3,8 - 3,2 kW	3,7 kW	4,2 kW	4,9 kW	6,8 kW	8,1 kW
COP SILENT Mode	6,7 - 5,6	7	6,7	6,6	6,7	6,5
Noise levels (min-max)	21 - 25 dB(a)	23 - 28 dB(a)	25 - 30 dB(a)	25 - 30 dB(a)	26 - 31 dB(a)	26 - 32 dB(a)



## BWT HPT PEARL INVERTER POOL HEAT PUMP AVAILABLE IN

<i>KW</i>	<i>PRODUCT CODE</i>
<b>9KW</b>	<b>BWTHPT09</b>
<b>15KW</b>	<b>BWTHPT15</b>
<b>20KW</b>	<b>BWTHPT20</b>

### PRODUCT OVERVIEW

The most intuitive, intelligent and efficient pool heat pump on the market.

- Simple and intuitive operation and optimal performance.
- Built in connection with BWT Pearl Connect app (available on App Store / Play Store) for smart phone management and control.
- Low noise levels.
- Energy efficient in 3 operating modes; max, eco, silent.

### Comprehensive Warranty

3 year initial product warranty + 2 years if the product is registered to PolyConnect.  
See terms and conditions for further information.

### TECHNICAL PARAMETERS

MODELS	BWT PEARL HPT09	BWT PEARL HPT15	BWT PEARL HPT20
Pool size guide	30-45m <sup>3</sup>	55-70m <sup>3</sup>	85-105m <sup>3</sup>
<i>Air 28°C / Water 28°C / 80% HR</i>			
Capacity in MAX Mode	9,5 kW	15,3 kW	20,1 kW
COP MAX Mode	6,3	6,3	6,1
Capacity in ECO Mode	9,5 - 3,2 kW	15,3 - 3,9 kW	20,1 - 5,5 kW
COP ECO Mode	10,8 - 6,3	10,8 - 6,3	10,8 - 6,1
Capacity in SILENT Mode	3,2 kW	3,9 kW	5,5 kW
COP SILENT Mode	10,8	10,8	10,8
<i>Air 15°C / Water 26°C / 70% HR</i>			
Capacity in MAX Mode	6,9 kW	11,0 kW	14,5 kW
COP MAX Mode	4,7	4,7	4,5
Capacity in ECO Mode	6,9 - 3,5 kW	11,0 - 5,0 kW	14,5 - 7,0 kW
COP ECO Mode	6,6 - 4,7	7,7 - 4,7	7,9 - 4,5
Capacity in SILENT Mode	3,5	5,0 kW	7,0 kW
COP SILENT Mode	6,4	6,5	6,6
Noise levels (min-max)	19 - 28 dB(a)	21 - 30 dB(a)	23 - 32 dB(a)



## BWT MINI CONNECT 4.3KW

**PRODUCT  
CODE  
BWTHPM25**

### PRODUCT OVERVIEW

The mini heat pump from BWT is ideal for heating smaller above-ground pools and spas with a water content of up from 15 m<sup>3</sup> to 25 m<sup>3</sup>. The heat pump is particularly compact and easy to operate. This allows the pool water to be tempered as desired and the bathing season to be extended.

- **PRACTICAL & COMPACT:** Small heat pump with small footprint, user-friendly and easy operation, simply connects to the house power
- **HEATING PERFORMANCE:** Max. Heat output 4.3 kW, ideal for above ground pools and spas between 15 and 25 m<sup>3</sup>
- **HIGH QUALITY COOLANT:** Environmentally friendly & efficient R32 coolant

### Comprehensive Warranty

3 year product warranty.  
See terms and conditions for further information.

### TECHNICAL PARAMETERS

BWT Mini Connect 25	
Recommended Pool Size	15 - 25 m <sup>3</sup>
<b>Air 26 ° C / Water 26 ° / 80% HR</b>	
Energy Output BOOST mode	4.3 kW
COP BOOST mode	5.3
<b>Air 15 ° C / Water 26 ° / 70% HR</b>	
Energy Output BOOST mode	3.1 kW
COP BOOST mode	4.5
<b>Air 7 ° C / Water 26 ° / 90% HR</b>	
Energy Output BOOST mode	2.4 kW
COP BOOST mode	2.5
Noise Levels	35 db(A)
Minimum water flow	2 m <sup>3</sup> /h
Pressure drop	16 kPa
Dimensions ( l x w x h )	430x290x375mm
Net weight	23.8 kg





## BWT STEPIO SPA HEAT PUMP 6.5 KW

**PRODUCT CODE**  
**BWTHPSTEP**

### PRODUCT OVERVIEW

The Stepio Spa Heat Pump by BWT features discrete and compact design made to fit underneath the steps of a spa pool. This unit ensures consistent heating of the spa pool at 38 degrees. Energy efficient with full inverter technology, low noise levels as it automatically adjusts the rotation speed of the compressor and fan to reduce noise to the minimum, simple, intuitive and completely automated via the BWT Connect App on your smartphone.

### Comprehensive Warranty

3 year initial product warranty + 2 years if the product is registered to PolyConnect.  
 See terms and conditions for further information.

### TECHNICAL PARAMETERS

Air 28°C/Water 38°C/80%HR	
Energy Output	6.5 kW
COP	4.6
Air 15°C/Water 38°C/70%HR	
Energy Output	4.4 kW
COP	3.4
Air 15°C/Water 26°C/0%HR	
Energy Output	5.2 kW
COP	4.6
Air -10°C/Water 38°C/0%HR	
Energy Output	1.1 kW
COP	0.9
Noise level (10m)	29 db(A)
Temp. working range	- 10°C up to 38°C
Compressor	2D Full DC Inverter
Expansion valve	Electronic
Exchanger	Coiled titanium
Housing	UV resistant ABS housing panels
Refrigerant	R32
Hydraulic connection	50mm
Power	230V
Max. intensity	6.2A
Min. water flow	3m <sup>3</sup> /h
Dimensions (l x w x h)	750 x 375 x 490 mm
Weight (net)	47 kg





## BWT CRYO INVERTER HEAT PUMP 4KW

**PRODUCT  
CODE  
BWTNPCRYO**

### PRODUCT OVERVIEW

The Cryo Inverter is specifically designed to cool down water to 5 degrees Celsius for cryotherapy applications and cold water therapy purposes. Thanks to the Full-Inverter technology, the CRYO PAC adjusts its operation according to the pool requirements, giving peace of mind, extension of the equipment's lifespan and 30% energy savings compared to a standard heat pump. Conventional installation, like a standard pool heat pump.

### Comprehensive Warranty

3 year initial product warranty + 2 years if the product is registered to PolyConnect.  
See terms and conditions for further information.

### TECHNICAL PARAMETERS

Air 32°C/Water 5°C	
Energy Output	4 kW
Energy Input	1.0 kW
Energy Efficient Ratio	2.65
Noise levels	28 - 32 db(A)
Temp. working range	- 10°C up to 35°C
Components	
Compressor	Inverter
Refrigerant	R32
Installation	
Hydraulic connection	50mm
Power	230V
Max. intensity	6.3A
Min. water flow	4m <sup>3</sup> /h
Dimensions (l x w x h)	936 x 322 x 567 mm
Weight (net)	33 kg







# SALT CHLORINATORS & POOL AUTOMATION

SPACE INDUSTRIES PRODUCT CATALOGUE  
2025

# INVERTER SALT POOL SOLUTIONS.

- Real-time automated chlorine production & pH regulation
- Low maintenance
- Smart automation



**AQUARK**<sup>®</sup>  
iOutdoor Living

## INTRODUCING THE AQUARK MR. PURE

INVERTURBO TECHNOLOGY adopts an advanced PID algorithm for accurate control of chlorine production and pH regulation. With self-adaptation to different situations, INVERTURBO TECH achieves high performance at low salt levels down to 1g/L and guarantees no additional salt maintenance for 180 days.

POOL & SPA EQUIPMENT  
SALT CHLORINATORS



**AQUARK MR. PURE  
INVERTER SALT CHLORINATOR  
AVAILABLE IN**

**MODEL**

**PRODUCT  
CODE**

**14G  
22G  
34G**

**QASCMP514P  
QASCMP522P  
QASCMP534P**

- ORP/pH/Temperature Reading
- One-click Turbo/Boost
- Salinity Reference
- Logs Review
- Mineral Salt Compatible

**PRODUCT OVERVIEW**

SEE the real-time water quality on the pad controller easily, even if you have no idea about chemistry. Thanks to INVERTURBO TECH, say goodbye to the hassle of adding salt. With no additional salt maintenance needed for 180 days, users can enjoy a totally hands-free pool experience all season long. Fully automated and controlled through smartphone application for ease of access.

**Comprehensive Warranty**

10,000 hours cell run time  
Controller unit - 3 years  
Probes and consumables - 1 year  
See terms & conditions for further information.

**TECHNICAL PARAMETERS**

Model	MPS14	MPS22	MPS34
Production at 130%( g/h, 3000PPM )	14.0	22.0	34.0
Production at 130%( g/h, 1000PPM )	7.0	12.0	19.0
Production at 100%( g/h, 3000PPM )	11.0	17.0	26.0
Salt Level (g/L)	1 ~ 5 (recommended 3g/L)		
Advised pool volume (m3) ( at 1800PPM )	20-35	35-50	50-90
TECHNICAL SPECIFICATIONS			
Advised water flux (m³/h)	5 ~ 20	5 ~ 20	5 ~ 20
Power Supply	100~240V 50/60Hz		
Power Consumption (W)	80	115	140
Output (A)	5.9	7	10
Voltage(V)	12		
Operating Temperature (°C)	-5 ~ 42 °C		
Salinity Test	Salt Level Detection (accuracy ±500PPM)		
Self-cleaning	Default 4h, 3 options in total (2/4/6h)		
Dosing Pump	Built-in/Integrated		
Communications	MODBUS RS485 / Wi-Fi / Dry Contact		
Control Unit Dimension LxWxH (mm)	202 x 270 x 75		
ELECTROLYSS CELL			
Water connection (mm)	63/60.3/50/48.3		
Water Temperature	10 ~ 40 °C		
Maximum Pressure	3 Bar		
Cell Life(h)	10,000		
Cell Dimension LxWxH (mm)	458×104×272	458×104×272	458×104×272
PACKAGING SPECIFICATIONS			
Net Weight (kg)	7	7	7
Gross Weight (kg)	9	9	9
Packaging Dimension LxWxH (mm)	550 x 400 x 300		
Qty per 20'FT/40'HQ (sets)	364/896		



**ONE-CLICK SIMPLICITY**

App control is enabled to keep you well informed of real-time water reports:

- ORP/pH/Temperature Reading
- One-click Turbo/Boost
- Salinity Reference
- Logs Review



## LINCOLN LSC SALT CHLORINATOR

### AVAILABLE IN

MODEL	PRODUCT CODE
20G	SPLESC20
30G	SPLESC30
50G	SPLESC50

### PRODUCT OVERVIEW

The Lincoln chlorinator range features an easy to use menu and a smart micro-computer controller system. It precisely adjusts chlorine output to 1% and includes an automatic self-cleaning feature.

#### Features

- Easy to use menu
- High salt/mineral indicator
- Smart micro-computer controller system
- Precision adjustment of chlorine output to 1%
- Auto-pilot mode
- Automatic power reduction when salt or mineral level is too high
- Automatic self cleaning on all models
- Run dry pump protection
- Water temperature reading
- Salt/mineral level test function

#### Comprehensive Warranty

10,000 hours

Controller unit - 3 years

See terms and conditions for further information.

### TECHNICAL PARAMETERS

Model	Chlorine production grams/hour	Max pool size
SPLESC20	20	55,000L
SPLESC30	30	75,000L
SPLESC50	50	120,000L

**\*75g and 100g models are available on request.**



## LINCOLN ECO SERIES SALT CHLORINATOR 20G

**PRODUCT  
CODE  
SPLESCECO20**

### PRODUCT OVERVIEW

Auto self cleaning. Suitable for Mineral, Magnesium & Sodium Salt pools.  
Recommended 3500 - 4000PPM.

- Easy to operate Analog Timer complete with internal re-charging Ni-Mh battery backup
- Self cleaning cell
- Automatic safety power reduction when salt high
- Proven high quality cell material
- 10 Increment LED display for accurate chlorine control
- Smart embedded micro-controller
- Works with any 230/240V Pump
- Stainless grade 304 mounting bracket with quick release pins
- Suitable for installation outdoors IP34 rated
- For pools between 35-55 m<sup>3</sup>

### Comprehensive Warranty

10,000 hours

Controller unit - 3 years

See terms and conditions for further information.



# YOUR PERSONAL POOL AUTOMATION MANAGER.

## INTRODUCING THE BWT EASYDOSE RANGE.

The EasyDose range of peristaltic pumps allows for automated dosing of chemicals for your pool. No need for weekly tests, treatment chemicals are injected automatically without any intervention by the user. Optimal, efficient and economical.



## BWT EASYDOSE PERISTALTIC PUMPS AVAILABLE IN

### TYPE

PH +/- AUTO MANAGER  
ORP AUTO MANAGER

### PRODUCT CODE

BWTMC5204  
BWTMC5205

## TECHNICAL PARAMETERS

	pH Auto Manager	ORP Auto Manager
Pool Volume	5-130m <sup>3</sup>	5-130m <sup>3</sup>
Flow Rate	1.5L/h at 1.5 bar	1.5L/h at 1.5 bar
Power Supply	230VAC - 50/60 Hz 9W	230VAC - 50/60 Hz 9W
Weight	950g	950g
Measurement Scale	3.8 - 8.2 pH	400 - 900 mV
Measurement Precision	± 0.1 pH	± 10 mV
Ambient Temperature	10 - 50 °C	10 - 50 °C
Display	High visibility LED	High visibility LED
Sensor Technology	pH sensor	ORP sensor
Dimensions(w/h/d) (mm)	89 x 138 x 118	89 x 138 x 118

### Comprehensive Warranty

1 year product warranty (excludes consumables). See terms and conditions for further information.

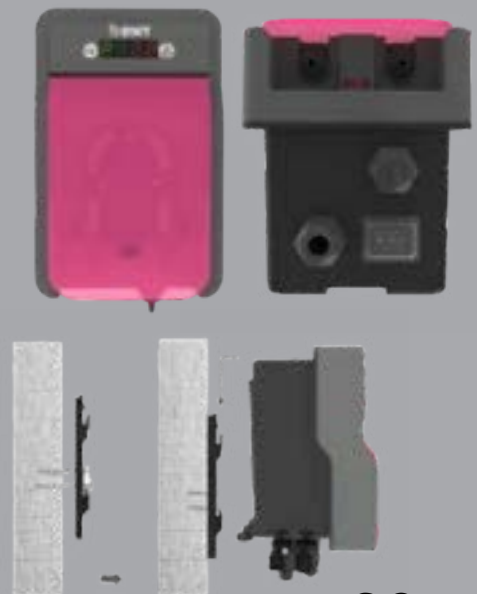

AQUAGEM

# POOL & SPA PUMPS



# THE WORLD'S FIRST FULL INVERTER POOL PUMP.



- World's most **silent pool pump**
- **FULL INVERTER** technology
- **Intuitive touch screen** controller
- **Energy efficiency** ensures it pays for itself



Full Inverter technology



Volute hydraulic system



DC brushless motor

## Comprehensive warranty

Parts - 3 years parts and labour plus additional 2 years on parts only.  
See terms and conditions for further information.

## INTRODUCING THE AQUAGEM INVERPRO

Combining full inverter technology, volute hydraulic system and DC brushless motor. It intelligently runs at 30-100% capacity for various applications like filtration and backwash. Additionally, it reduces sound levels over 30 times and saves energy up to 15 times compared to a regular pool pump.







# AQUAGEM INVERPRO FULL INVERTER POOL PUMP



## AVAILABLE IN

HP	PRODUCT CODE
1 HP	QGVPIP20
1.5 HP	QGVPIP25
2 HP	QGVPIP30

## PERFORMANCE CURVE

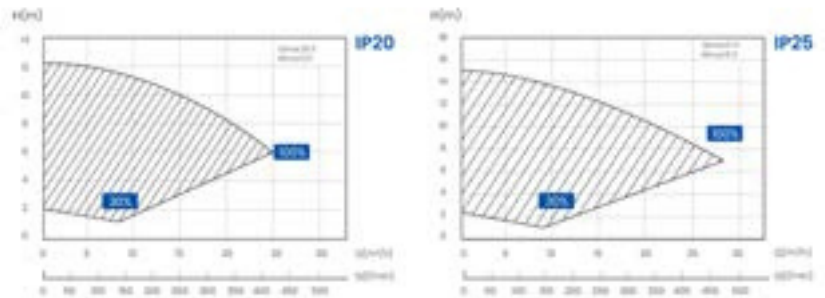

## PRODUCT OVERVIEW

- Full Inverter by InverSilence® Tech
  - Up to 15x more energy efficient \*
  - Up to 30x more silent \*
  - Power Consumption Reading
  - Intelligent Full Touch Controller
- \*comparison is based on traditional pool pumps

AUTO/MANUAL inverter mode optional	External control	Power consumption reading
WIFI optional	Flow reading	One-click backwash

## TECHNICAL PARAMETERS

Model	Pool volume m <sup>3</sup>	P1 (kW)	Voltage (V/Hz)	Qmax	Hmax	Circulation Flow (m <sup>3</sup> /h) 30%-100%
IP20	30-50	0.07-0.77	220-240/50/60	25	12.5	4.5-15
IP25	40-70	0.08-1.05	220-240/50/60	27.5	15	6.6-22
IP30	50-80	0.09-1.40	220-240/50/60	31	18	8.1-27



### PRODUCT OVERVIEW

The Bravo Single Speed Pool Pump is designed with features specifically tailored for both fresh and salt pools. It includes a stainless steel shaft and glass filled poly-propylene construction with high UV protection for strength and durability. The carbon ceramic mechanical seal ensures reliable performance. The pump is equipped with top-quality bearings sourced from TPI-Taiwan and features a large leaf basket with a clear view lid for easy maintenance. It comes with 40mm and 50mm fitting unions, a 1.5m suction end on high speed, and a ready-to-go plug with a 3m flex. The built-in overload thermal protector, made in the USA, enhances safety. With IP55 water ingress protection and compliance with AS/NZS60335.1 & AS/NZS60335.2.41 standards, this pump is built to last. Operating at a single phase of 240V/50Hz and suitable for temperatures below 35°C for water and 50°C for the ambient environment.

### Comprehensive warranty

3-year domestic warranty (including a 2-year Mechanical Seal warranty and 1-year commercial warranty). See terms and conditions for further information.

## BRAVO SINGLE SPEED POOL PUMP

AVAILABLE IN

HP	PRODUCT CODE
0.75 HP	BBPB07
1 HP	BBPB10
1.5 HP	BBPB15
2 HP	BBPB20
2.5 HP	BBPB25

### PERFORMANCE CURVE

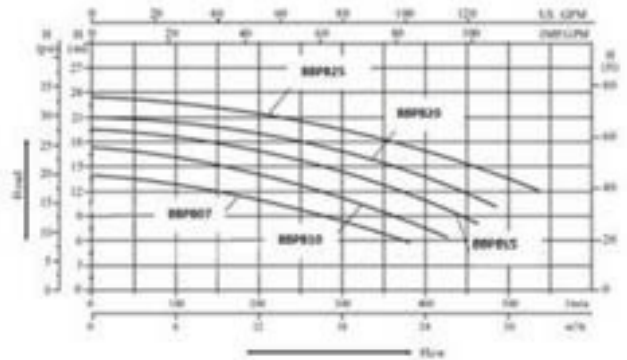

### TECHNICAL PARAMETERS

model code	max Head(m)	max Lpm	input kW	output kW	output HP	amps	size LxWxH	weight (kg)
BBPB07	14.5	340.0	0.75	0.55	0.75	3.8	593x240x320	13.5
BBPB10	17.0	420.0	1.10	0.75	1.0	5.2	593x240x320	15.5
BBPB15	19.0	465.0	1.50	1.10	1.5	7.0	593x240x320	17.5
BBPB20	21.0	480.0	1.85	1.50	2.0	8.6	593x240x320	18.5
BBPB25	23.0	540.0	2.20	1.85	2.5	10.0	609x240x320	20.0



## LIGHT DUTY POOL PUMPS AVAILABLE IN

<i>HP</i>	<i>PRODUCT CODE</i>
<b>0.25HP</b>	<b>BBPH0.25</b>
<b>0.33HP</b>	<b>BBPH0.33</b>
<b>0.7HP</b>	<b>BBPH07</b>
<b>1.0 HP</b>	<b>BBPH10</b>

### PRODUCT OVERVIEW

- Medium duty, entry level pool pump
- Quiet operation
- Inner and outer thread design
- Liquid temperature <60°C
- IPX5
- Anodised motor body
- Overload protection
- Huge pro-filter for less cleaning maintenance
- Heightened pump base to keep out of water or moist environment

### Comprehensive warranty

3-year domestic warranty (including a 2-year Mechanical Seal warranty and 1-year commercial warranty).  
See terms and conditions for further information.





## DELTA DUAL SPEED SPA PUMP 0.3/2.0 HP

**PRODUCT  
CODE  
BBSO0320**

### PRODUCT OVERVIEW

The Delta Dual Speed Spa Pump features a nickel-plated #45 steel shaft for added durability. Its glass-filled poly-propylene construction provides exceptional strength and high UV protection.

The pump is equipped with a reliable carbon ceramic mechanical seal and top-quality bearings sourced from TPI-Taiwan. With 50mm fitting unions, installation is a breeze. The built-in overload thermal protector, made in the USA, ensures safety and peace of mind. Meeting IP55 water ingress standards, this pump is designed for durability and longevity. Operating at a single phase of 240V/50Hz, it can handle water temperatures below 40°C and ambient temperatures below 50°C.

Compliance with AS/NZS60335.1 & AS/NZS60335.2.41 standards guarantees its quality and performance.

### Comprehensive warranty

1-year domestic warranty, (including a 6-month Mechanical Seal warranty and commercial warranty).

See terms and conditions for further information.

### PERFORMANCE CURVE

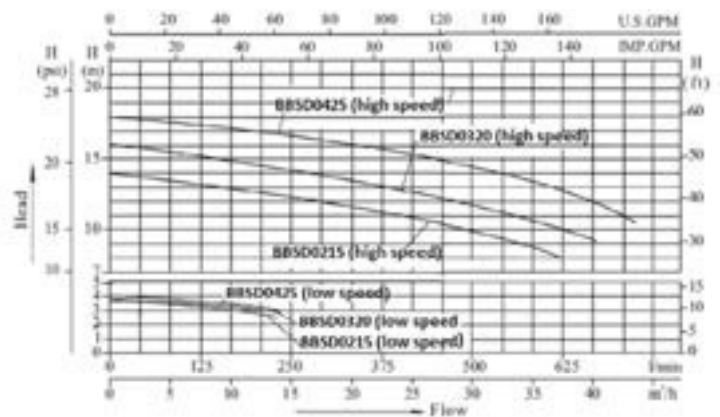

### TECHNICAL PARAMETERS

Max Head (m)	max Lpm	Input kW	Output kW
16	670	0.4/1.85	0.26/1.5
Output HP	Amps	Size (l x w x h)	Weight (kg)
0.3/2.0	9	434x202x197	17



# ECHO SINGLE SPEED SPA PUMP

AVAILABLE IN

HP	PRODUCT CODE
1.1 HP	BBSE11
1.5 HP	BBSE15
2 HP	BBSE20
2.5 HP	BBSE25

## PRODUCT OVERVIEW

The Echo Single Speed Spa Pump featuring a nickel-plated #45 steel shaft for exceptional durability. Its glass-filled polypropylene construction ensures strength and high UV protection.

Equipped with a reliable carbon ceramic mechanical seal and top-quality bearings sourced from TPI-Taiwan, this pump delivers reliable performance. With 50mm fitting unions, installation is quick and easy. The built-in overload thermal protector, made in the USA, offers added safety. Meeting IP55 water ingress standards, this pump is built to withstand various conditions. Operating at a single phase of 240V/50Hz, it maintains optimal performance in water temperatures below 40°C and ambient temperatures below 50°C.

Compliant with AS/NZS60335.1 & AS/NZS60335.2.41 standards, this pump ensures quality and reliability.

## Comprehensive warranty

1-year domestic warranty, (including a 6-month Mechanical Seal warranty and commercial warranty).  
See terms and conditions for further information.

## PERFORMANCE CURVE

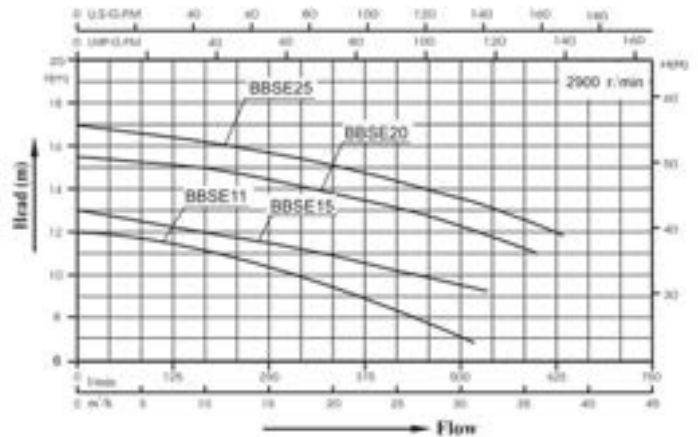

## TECHNICAL PARAMETERS

model code	max Head(m)	max Lpm	input kW	output kW	output HP	amps	size LxWxH	weight (kg)
BBSE11	12	520	1.1	0.75	1.0	5.8	382x202x218	12
BBSE15	13	535	1.5	1.1	1.5	7.0	382x202x218	12.7
BBSE20	15.5	600.0	1.85	1.50	2.0	8.0	382x202x218	14.6
BBSE25	17.0	635.0	2.20	1.85	2.5	10.0	397x202x218	16.3



# FOX SINGLE SPEED SPA PUMP

AVAILABLE IN

HP	PRODUCT CODE
0.25 HP	BBSF02
0.35 HP	BBSF03
0.5 HP	BBSF05
1 HP	BBSF10

## PRODUCT OVERVIEW

Discover the Fox Spa Pump with durability and performance in mind. It features a nickel-plated #45 steel shaft for exceptional strength. The glass-filled poly-propylene construction offers superior UV protection.

With a reliable carbon ceramic mechanical seal and top-notch bearings sourced from TPI-Taiwan, this pump ensures reliable operation. The 50mm fitting unions make installation quick and hassle-free. The built-in overload thermal protector, made in the USA, enhances safety. Meeting IP55 water ingress standards, this pump is designed to withstand demanding conditions. Operating at a single phase of 240V/50Hz, it performs optimally in water temperatures below 40°C and ambient temperatures below 50°C.

Complying with AS/NZS60335.1 & AS/NZS60335.2.41 standards, this pump guarantees quality and reliability.

## Comprehensive warranty

1-year domestic warranty, (including a 6-month Mechanical Seal warranty and commercial warranty).  
See terms and conditions for further information.

## PERFORMANCE CURVE

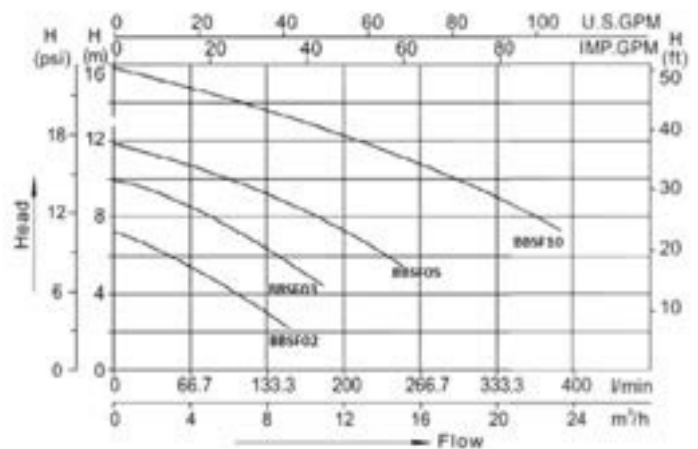

## TECHNICAL PARAMETERS

model code	max Head(m)	max Lpm	input kW	output kW	output HP	amps	size LxWxH	weight (kg)
BBSF02	7.5	150	0.25	0.19	0.25	1.6	317x153x191	5.1
BBSF03	10.0	180.0	0.37	0.26	0.35	2.0	317x153x191	5.9
BBSF05	12.0	250.0	0.55	0.37	0.5	3.2	347x156x205	7.9
BBSF10	13.0	335.0	0.9	0.75	1.0	4.6	347x156x205	9.1



## SPA POOL CIRCULATION PUMP 250-WATT

**PRODUCT  
CODE  
BBWTC50M**

### PRODUCT OVERVIEW

Our versatile spa circulation pump is designed for both Hydro Massage Tubs or Spa Systems and swimming pool circulation or filtration. With a P1 input of 0.25 KW / 1/3hp and a P2 output of 0.25hp, it delivers efficient performance. The pump comes with 2 x 48.5 union fittings for easy installation. It includes a 3mtr flex with an Amphenol plug, ensuring convenience.

This pump is engineered to handle a wide range of applications and provides reliable performance in various working conditions.

Operating Conditions:

- Medium Temperature: 5-50°C
- Environmental Temperature: 50°C
- Maximum Working Pressure: 0.3MPa

### Comprehensive warranty

1-year domestic warranty, (including a 6-month Mechanical Seal warranty and commercial warranty).

See terms and conditions for further information.

### PERFORMANCE CURVE

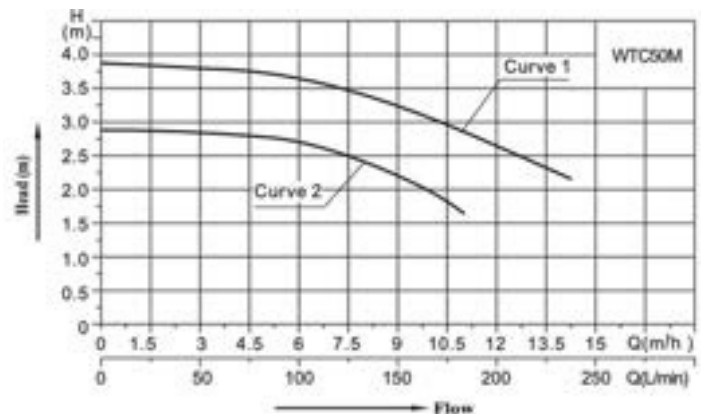

### TECHNICAL PARAMETERS

V/HZ	Speed (rpm)	Power (kW/HP)	Amps
230/50	1400	0.25/0.35	1
Qmax (L/min)	Hmax (m)	Size (l x w x h)	Weight (kg)
240	3.8	320x180x210	6

# LX SPA AIR BLOWERS



## BBAPR400-V2

- 400 watt
- 40mm union 1.5m flex and Amphenol plug without heater



## BBAPR900-V2

- 900 watt
- 40mm union 1.5m flex and Amphenol plug without heater



## BBAPR700-V2

- 700 watt
- 40mm union 1.5m flex and Amphenol plug without heater

### Comprehensive warranty

1-year product warranty.

See terms and conditions for further information.



# SAND FILTERS & COMBO KITS





## AQUAFINZ GLOSS FIBREGLASS SAND FILTER

AVAILABLE IN

*DIAMETER  
O/D*

*PRODUCT  
CODE*

**550**

**BBSF550KIT**

**650**

**BBSF650KIT**

**650**

**BBSF650SKIT (Side Mount MPV)**

**750**

**BBSF750KIT**

### PRODUCT OVERVIEW

Our new Aquafinz Sand Filter with laminated fiberglass top mount filter is durable, corrosion-resistant and features a glossy finish in gel coat for a smooth and beautiful exterior. This collection of sand filters is the perfect choice for high-end villas and hotel pools, high-class spas and wellness pools, baths and fish ponds.

- Non corrosive gel coat fiberglass tank, smooth gloss finish.
- Equipped with a 1.5" or 2.0" six-position multiport valve.
- Universal standard of union connection provided.
- Max. working pressure 36 psi/2.5 bar.
- Max. temperature of 43°C(109°F)
- Suggested size of media: 0.5-0.8mm.

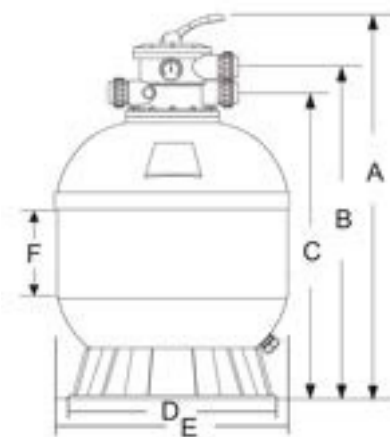

### Comprehensive warranty

10-year product warranty (excludes consumables).  
See terms and conditions for further information.

### TECHNICAL PARAMETERS

Model	Max flow rate		Filter area m <sup>2</sup>	Port size		Sand kg	Dimension(mm)					
	lpm	m <sup>3</sup> /h		inch	mm		A	B	C	D	E	F
<b>Multiport valve W 1.5</b>												
L550	167	10.00	0.20	1.5"	50	88	886	750	690	390	530	286
L650	275	16.50	0.33	1.5"	50	158	1000	850	790	500	640	318
<b>Multiport valve W 2.0</b>												
L750	366	22.00	0.44	2"	63	260	1170	1005	920	710	750	390



## BLUEY FIBREGLASS SAND FILTER KITS AVAILABLE IN

DIAMETER O/D	PRODUCT CODE
525	BBSF500
625	BBSF600
700	BBSF700

### PRODUCT OVERVIEW

Removing unwanted additions to your pool is critical to pool health. You need a filter that can not only retain this washout from filtration but handle the high pressure action of a good pump. Bluey filters are solid wound fibreglass. They are UV & chemical resistant and handle up to 36psi.2.5bar.

Every Bluey comes standard with a 6 position Multi port valve with sight glass and SS pressure gauge. Ideal for use on any sort of pool regardless of whether fresh or salt water.

### Comprehensive warranty

5-years on parts. Excludes spider valve seal.  
See terms and conditions for further information.

### TECHNICAL PARAMETERS

Code	Description	Suits pools up to (ltr)	Valve (mm)	Max Flow (l/pm)	Filter Area (m²)	Height	Diameter (O/D)	Pool Sand (kg)
BBSF500	Bad Boy Fibreglass Sand Filter 525	56,000	40	190	0.22	880	525	85
BBSF600	Bad Boy Fibreglass Sand Filter 625	81,000	40	270	0.3	1005	625	150
BBSF700	Bad Boy Fibreglass Sand Filter 700	110,00	50	350	0.4	1150	700	200



## WE SELL SPARE PARTS!

Space Industries offers spare parts for certain products and models. Feel free to contact us on **(09) 262 3902** or email us on **reception@spaceindustries.co.nz**.



## POOL PUMP AND FILTER COMBO AVAILABLE IN

MM	WATTS	PRODUCT CODE
300	250	BBPFCOMBO
400	370	BBPFCOMBOL

### PRODUCT OVERVIEW

SAA CERTIFIED Includes Easy read instructions & diagrams, Filter, Plinth base Pump Jointing hose, Modular fittings to suit most pool brands.

**BBPFCOMBO requires: 19kg of pool sand, for above ground pools up to 25,000L**  
**BBPFCOMBOL requires: 30kg of pool sand, for above ground pools up to 40,000L**



## POOL PUMP AND FILTER COMBO 10KG/90W

PRODUCT CODE  
**PSP90W**

### PRODUCT OVERVIEW

All in one simple ready-to-go option for small pools. This filter and pump combo will suit all above ground pools up to 27000L. Water Flow: 3000L/HP: 90 watt/Voltage: AC220-240v/Pools with 32MM fittings Fittings: Comes with fitting hoses and clamps to fit your 32mm drain points Measurements: 37 X 32.5 X 58 Requires 10KG of sand.

### Comprehensive warranty

12-month warranty.

See terms and conditions for further information.

## ABOVE GROUND POOL PUMP 60W

PRODUCT CODE  
**PSP60W**

### PRODUCT OVERVIEW

Perfect for above ground pools and fits most brands of soft sided pools up to 20,000 L. 56L min flow rate is much stronger than conventional models. Comes with Cartridge filter with 50% more filter area than conventional models. Comes with replacement hoses and hose clamps.

### Comprehensive warranty

12-month warranty.

See terms and conditions for further information.





# POOL & SPA VACUUM CLEANERS





### Comprehensive warranty

12-month product warranty, excludes consumables.  
See terms and conditions for further information.

## KOKIDO BOREAL EV01 SPA VACUUM

**PRODUCT CODE: EV01CBX/SPA/AU**  
**PRODUCT OVERVIEW**

Ctn Qty: 4

- For spa pools 1.5m Maximum
- Operating Depth
- Cleans Spa Floor
- 30 Mins Of Battery Life
- 4-5 Hours Charging Time
- 0.1L Debris Capacity



### Comprehensive warranty

12-month product warranty, excludes consumables.  
See terms and conditions for further information.

## KOKIDO TELSA EV05 SPA VACUUM

**PRODUCT CODE: EVO5CBX/EU**  
**PRODUCT OVERVIEW**

Ctn Qty: 4

- For small pools
- 3m Maximum Operating Depth
- Cleans Pool Floors and Waterline
- 30 Mins Of Battery Life
- 4-5 Hours Charging Time
- 0.42L Debris Capacity



### Comprehensive warranty

12-month product warranty, excludes consumables.  
See terms and conditions for further information.

## KOKIDO TELSA EV30 POOL VACUUM

**PRODUCT CODE: EV30CBX/AU**  
**PRODUCT OVERVIEW**

Ctn Qty: 2

- For Medium-Sized Pools Up To 15 m<sup>3</sup>
- 3m Maximum Operating Depth
- Cleans Pool Floor And Walls
- 30 Mins Of Battery Life
- 5-6 Hours Charging Time
- 0.9L Dirt Collector Capacity



### Comprehensive warranty

12-month product warranty, excludes consumables.  
See terms and conditions for further information.

## KOKIDO VOLTERA 75 CORDLESS RECHARGEABLE POOL/SPA VACUUM

**PRODUCT CODE: EV75CBX/AU**

### PRODUCT OVERVIEW

Ctn Qty: 1

- For Large Pools Up To 35 m<sup>3</sup>
- 3m Maximum Operating Depth
- Versatile On All Types Of Pools
- 75 Mins Of Battery Life
- 5-6 Hours Charging Time
- 3L Dirt Collector Capacity

***Replacement filter cartridge twin pack available for purchase (EV75CBX/FILTERSX2)***



### Comprehensive warranty

12-month product warranty, excludes consumables.  
See terms and conditions for further information.

## KOKIDO VOLTERA 105 POWERFUL LARGE VOLUME RECHARGEABLE POOL VACUUM

**PRODUCT CODE: EV105CBX/24/AU**

### PRODUCT OVERVIEW

Ctn Qty: 2

- For Large Pools Up To 35 m<sup>3</sup>
- 3m Maximum Operating Depth
- Flexible extensions facilitate cleaning over curved pool surfaces
- 75 Mins Of Battery Life
- 5-6 Hours Charging Time
- Extra wide body for large amounts of leaves
- 3L Dirt Collector Capacity



## KOKIDO TELSA EV40 POWERBLADE

**PRODUCT CODE: EV40CBX/AU**

### PRODUCT OVERVIEW

Ctn Qty: 2

- For Large Pools Up To 25 m<sup>3</sup>
- 3m Maximum Operating Depth
- Perfect For Cleaning Leaves And Dirt In Pool
- 75 Mins Of Battery Life
- 5-6 Hours Charging Time
- 6.5L Dirt Collector Capacity

A photograph of a swimming pool with various pool maintenance tools in the foreground. The tools include a blue and white vacuum head, a long-handled brush, a blue and white skimmer, and a blue and white pump head. A blue and white flexible hose is also visible. The pool water is clear and blue, and the background shows a concrete pool deck and a building with a white awning. The sun is shining brightly, creating a warm, golden glow over the scene.

# CONSUMABLES





POOL & SPA EQUIPMENT  
CONSUMABLES



**STANLEY DLX 18" FLEXIBLE  
POOL BRUSH 45 CM**  
ST20876

Ctn Qty: 4

Heavy duty, long lasting nylon bristles. Extra-wide body. Flexible curve design for superior functionality. Die-cast aluminium handle.



**STANLEY DLX VINYL VAC**  
ST27812

Ctn Qty: 6

The Stanley Pooltec DLX Liner Vac Head is a heavy and solidly constructed vac head suited to most above ground pools. Uses standard telescopic pole fittings.



**STANLEY DLX ALUMINIUM  
LEAF RAKE**  
ST21177

Ctn Qty: 6

Aluminium inner frame with black polymer mark-resistant rim. Durable pocket screening made of close-mesh netting. Works with any 32mm diameter pole.



**STANLEY DLX ALUMINIUM  
LEAF SKIMMER**  
ST21180

Ctn Qty: 6

For removing surface leaves and debris from pool or spa. Durable pocket screening made of close-mesh netting. Mark-resistant polymer rim. Works with any standard 1¼ in (32mm) diameter pole.



**STANLEY POOL DISPENSER**  
ST32855

Ctn Qty: 12

Provides consistent protection with continual amounts of chlorine. Automatic release eliminates day-to-day maintenance. Adjustable chlorinating ring. Holds up to 3 in (76mm) tablets or sticks.



**STANLEY SPA DISPENSER**  
ST32857

Ctn Qty: 12

Provides consistent protection with continual amounts of sanitiser. Automatic release eliminates day-to-day maintenance. Adjustable chlorinating ring. Holds 1 in (25mm) pills.

POOL & SPA EQUIPMENT  
CONSUMABLES



**STANLEY DLX  
THERMOMETER**  
ST25800

Ctn Qty: 12

Floating thermometer accurately measures water temperature. Removable snap-on float and polyethylene cord allows for use as a floating or submersible thermometer. Easy to read dual temperature scales. Shatter resistant lens.



**STANLEY FLEX VACUUM**  
ST27809

Ctn Qty: 6

For removing debris from pools with hard-surface finish. The flexible body handles corners and other curves on the floor of the pool or spa. Works with any standard 32 mm diameter pole.



**VACUUM BRUSH FOR  
VINYL POOLS**  
VAB

Ctn Qty: 6

Ideal for deep pool cleaning. Fits all standard pool poles. Fits 38mm or 32mm hose types



**STANLEY TELESCOPIC POLES**

3.6M **ST21813**  
4.9M **ST21817**

Ctn Qty: 4

Swimming Pool Telescopic Pole available in 3.6M or 4.9M. 32mm diameter to fit all NZ style pool equipment.



**TELESCOPIC POLES**

**POL927 (2 X 240 CM)**  
**POL120 (2 X 120 CM)**  
**POL3 (3 X 1.1M)**  
**POL180 (2 X 180 CM)**

Standard telescopic pole to fit all NZ style pool equipment.

POOL & SPA EQUIPMENT  
CONSUMABLES



**FLOATING DISPENSER  
SMALL 20G  
FDS**

Ctn Qty: 12

Expandable and adjustable. Takes 20g pills and holds up to 8 pills.



**FLOATING DISPENSER  
LARGE 200G  
FDL**

Ctn Qty: 6

Expandable and adjustable. Takes 200g tablets and holds up to 5 tablets.



**BOREAL FLOATING SPA  
DISPENSER  
K676BU/SPA**

Ctn Qty: 6

Floating spa dispenser for 38 mm / 1½ inch tablets. Holds up to 8 tablets.



**SEGMENTED HOSE  
32 MM X 3M  
PSHOSE3**

Ctn Qty: 12

Segmented 32mm x 3m hose to replace above ground pool hoses. Can be cut at 1m intervals.



**HEAVY DUTY POOL HOSE  
38 MM X 11 M  
HOS3811 HD**

Ctn Qty: 4

This pool vacuum hose fits all the standard vacuum heads  
Size: 11m x 38mm, Robust construction. Durable plastic spiral construction. Comes with 2 end cuffs.



**POOL HOSE  
38 MM X 12 M  
HOS3812 BLAC**

Ctn Qty: 2

Heavy duty, crush resistant pool hose. UV and chemical resistant ensuring the hose is durable and built to last. Comes with swivel cuffs providing flexibility and kink-free operation. 12m x 38mm.

POOL & SPA EQUIPMENT  
CONSUMABLES



**BOREAL SPA POOL KIT**  
**3 PC**  
**PK17CS/SPA**

Ctn Qty: 8

Includes 3-pc Pole, skimmer net 23cm x 20cm, brush 13cm W. Includes removable Handle EZ-grip.



**BOREAL SPA POOL KIT**  
**7 PC**  
**PK20CBX/SPA**

Ctn Qty: 4

The kit includes a brush, a skimmer net, a scrubbing glove, a 3-section aluminum handle, two absorbent sponges, a floating thermometer, and a chemical dispenser.



**WISHBONE FOR**  
**TELESCOPIC POLES**  
**POW**

Ctn Qty: 1

Wishbone Clips are hose attachments for telescopic handles that help lock the handle in place to achieve the right height and length for your needs. Fits most standard poles.



**LEAF SCOOP**  
**LEAS**

Ctn Qty: 6

Lightweight streamlined design effortlessly skims leaves and debris floating on water's surface.



**WIDE MOUTH SKIMMER**  
**BASKET**  
**SKB**

Ctn Qty: 1

Skimmer basket replacement, fits Vogue Pools.



**LEAF RAKE**  
**LEAR**

Ctn Qty: 12

Scoops out small debris and floating garbage from your swimming pool, pond, hot tub, fountain or large fish tank. Its fine mesh bag is deep and retains the debris while letting the water go.

POOL & SPA EQUIPMENT  
CONSUMABLES



**JET VAC KIT WITH 5 X  
SECTION POLE 120 CM**  
K189CS/B

Ctn Qty: 6

Simply attach your garden hose to the vacuum head which will create a vacuum effect and pick up the debris on the pool floor whilst moving it backwards and forwards. The Jet Vac includes a 5 section pole and debris bag.



**KOKIDO 6 PC POOL KIT**  
K485CS/3W

Ctn Qty: 6

includes a brush, a rake, a jet vac, a floating dispenser, a pack of multi-pills to remove debris and a thermometer to check the temperature. This kit makes a great essential for your new pool.



**SOLARIS AG COVER REEL**  
K651CBX

Ctn Qty: 1

Complete set includes reel, mounting hardware, 7-piece hexagonal tube set, and strap kit. Suitable for above ground pools up to 18' wide.



**KOKIDO STEP N WASH  
POOL FOOT BATH**  
K672BU

Ctn Qty: 12

Helps prevent grass and dirt from being carried into the pool and therefore may reduce chemical consumption and frequency of cleaning.



**ROUND TUBULAR  
THERMOMETER**  
THF

Ctn Qty: 12

Measures in Celsius and Fahrenheit, includes cord 190mm long.



**LUV-A-DUCK SERIES  
THERMOMETER**  
TM08CB

Ctn Qty: 12

Original and playful pattern, measures pool temperature. Securing cord with hook to hold on stairs & suction cup to hold on pool wall.



# POOL AND SPA CHEMICALS

# BALANCE CHEMICALS



Water balance is a crucial aspect in pool maintenance. Maintaining a healthy pH balance ensures that your sanitising chemicals are working efficiently, decreases the probability of problems such as algae growth and prolongs your pool and pool equipment.





## pH BUFFER

pH Buffer (Sodium Bicarbonate) has the ability to resist changes in the pH levels of water and buffers the water from wild pH swings. It will raise the total alkalinity in swimming pools and spa pools.

SIZES	CODE	CARTON QTY
1kg	CPHB01	12
2kg	CPHB02	6
4kg	CPHB04	4
10kg	CPHB10	2
25kg	PHB25	N/A



## pH INCREASE

pH Increase (Soda Ash) is used to raise pH levels in swimming pools and spa pools. Neutral water has a pH of 7.0. A pH reading below 7.0 indicates the water is acidic and a reading above 7.0 indicates the water is alkaline.

SIZES	CODE	CARTON QTY
1kg	CPHI01	12
2kg	CPHI02	6
4.5kg	CPHI04.5	4
25kg	PHI25	N/A



## pH DECREASE

pH Decrease (Sodium Bisulphate) is used to lower pH levels in swimming pools and spa pools. Neutral water has a pH of 7.0. A pH reading below 7.0 indicates the water is acidic and a reading above 7.0 indicates the water is alkaline.

SIZES	CODE	CARTON QTY
1kg	CPHD01	12
2kg	CPHD02	6
4.5kg	CPHD04.5	4
10kg	CPHD10	N/A
25kg	PHD25	N/A



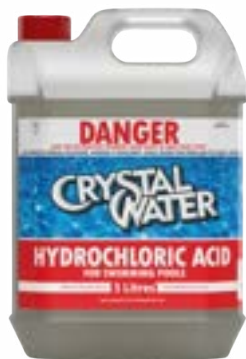

## HYDROCHLORIC ACID

Hydrochloric Acid (25% concentration) can be used to reduce the pH and/or total alkalinity of a pool.

SIZES	CODE	CARTON QTY
5L	CHYA0525	4
20L RF*	CHYA2025	N/A
20L NF*	CHYA20X25IMP	N/A

\*20L CHYA2025 has a refundable deposit.

\*20L CHYA20X25IMP is non refundable.



## CHLOR SAVE

Chlor Save (Cyanuric Acid) is a stabiliser used to slow down the rate at which free chlorine is destroyed by sunlight.

SIZES	CODE	CARTON QTY
1.0kg	CCHST01 (Tablets 200gm x 5)	6
1.5kg	CCHS01.5	4
3kg	CCHS03	N/A
10kg	CCHS10	N/A
25kg	CHS25	N/A



## CALCIUM HARDENER

Calcium Hardener (Calcium Chloride) is used to balance the total water hardness of your pool water, ensuring that calcium and magnesium levels are optimal.

SIZES	CODE	CARTON QTY
750g	CCAH0.75	12
1.5kg	CCAH01.5	6
3kg	CCAH03	4
10kg	CCAH10	2
25kg	CAH25	N/A

# ALGAEICIDE CHEMICALS



Having an effective algaecide is one of the most important tools in the pool maintenance arsenal. They are designed to kill algae, which can grow in your pool if you don't take care of it. There are many dangers of not treating algaecide, including skin issues and bacterial infections.





## CLEAN THE GREEN

Clean The Green helps in the removal and prevention of green black mustard blue-green and other swimming pool algae. Can also be used on hard surfaces such as paths paving asphalt driveways and timber.

SIZES	CODE	CARTON QTY
1L	CLG01	6



## POOL KLEER

Pool Kleer is a copper and quaternary complex algaecide and sanitiser for swimming pools. Helps to keep pool water clear and free of visible algae.

SIZES	CODE	CARTON QTY
2L	CPKA02	6
5L	CPKA05	4
20L	CPKA20	N/A



## POOL WINTERISER

Pool Winteriser is a long-lasting winter solution for swimming pools that provides an effective barrier against algae growth through pool hibernation that lasts up to 5 months.

SIZES	CODE	CARTON QTY
2L	CWIN02	6



## SALTE ALGAECIDE

Salte Algaecide is a non-copper formulation making it ideal for pools with salt cell chlorine generators. An independently strong formulation with a control period up to 2 months.

SIZES	CODE	CARTON QTY
1L	CSAA01	6
2L	CSAA02	6
20L	CSAA20	6



## SUPER ALGAECIDE

Super Algaecide is a non-copper algaecide used for pools containing heavy black algae growth.

SIZES	CODE	CARTON QTY
1L	SUA01	6
5L	SUA05	4



## COMMERCIAL ALGAECIDE

Strong algaecide used in high-maintenance pools with higher bather load. Suitable for chlorine or salt pools. Does not contain copper.

SIZES	CODE	CARTON QTY
20L	Q5020CA	N/A

# SANITISER CHEMICALS



Pool and spa sanitisers are used to kill and eliminate any harmful bacteria in your water, keeping sanitation levels safe and your pool or spa ready to use whenever you please.





## LIQUA CHLOR

Liquid Chlorine (Sodium Hypochlorite >15%) is effective against most bacteria algae and other micro-organisms and is excellent for maintaining a free chlorine residual in pool water.

SIZES	CODE	CARTON QTY
5L	CLCH05	4
10L	CLCH10	N/A
20L	CLCH20	N/A
100L	CLCH100	N/A
200L	LCS200	N/A



## CHLORINE GRANULES

Chlorine Granules (Calcium Hypochlorite 70% Concentration) is an ideal water sanitiser for both shock and maintenance dose summer and winter use.

SIZES	CODE	CARTON QTY
4kg	CPCG04	4
10kg	CPCG10	N/A
25kg	CPCG25	N/A
40kg	CWCG40	N/A



## DICHLOR GRANULES

Dichlor Granules is 100% soluble, fast-dissolving stabilised chlorine granules for the control of algae and bacteria in swimming pools.

SIZES	CODE	CARTON QTY
5kg	CDIC05	N/A
10kg	CDIC10	N/A
25kg	CDIC25	N/A



## TRICHLOR TABLETS

Trichlor Tablets are slow-dissolving tablets that provide a source of chlorine to sanitise your pool water. They are stabilised to protect chlorine from UV degradation.

SIZES	CODE	CARTON QTY
1kg	CTRI01	6
2kg	CTRI02	6
4kg	CTRI04	4
10kg	CTRI10	1
20kg	CTRI20	N/A
40kg	CTRI40	N/A



## TRICHLOR PILLS

Trichlor Pills (20G) automatically chlorinate the water without the need for daily dosing. They are less susceptible to degradation by sunlight. Ideal for small splashers & Intex type pools.

SIZES	CODE	CARTON QTY
10kg	CTRP10	1
20kg	CTRP20	1



## MULTI TABLETS

Crystal Water Multi Tablets (200G) is a slow-dissolving, 4-way-action sanitiser: Chlorine (sanitiser), Cyanuric (stabiliser), Floc (drops suspended particles), Algaecide (inhibits algae growth).

SIZES	CODE	CARTON QTY
1kg	CMUT01	6
2kg	CMUT02	6
4kg	CMUT04	4
40kg	MUT40	N/A



## MULTI PILLS

Crystal Water Multi Pills are a slow-dissolving, 4-way-action sanitiser: Chlorine (sanitiser), Cyanuric (stabiliser), Floc (drops suspended particles), Algaecide (inhibits algae growth). 1 container contains 50 pills.

SIZES	CODE	CARTON QTY
1kg	CMUP01	6



## INSTA CHLOR

Insta Chlor is a 100% soluble, fast-dissolving stabilised chlorine for the control of algae and bacteria in swimming pools. Comes in a resealable bag.

SIZES	CODE	CARTON QTY
600g	CIN0.6	10



## REFRESH

Crystal Water Refresh is a quick pick-me-up fast action chlorine solution to boost water clarity and cleanliness. Simply pour and swim as the pool will be good to go after 60 minutes.

SIZES	CODE	CARTON QTY
400g	CWREF0.4	15





## BROMINE TABLETS

Bromine Tablets (20G) are effective as a spa and hot tub water sanitiser. They have been designed to keep spa and hot tub water sparkling clean by continuous treatment through a feeder (brominator) or the skimmer.

SIZES	CODE	CARTON QTY
1kg	CBRT01	6
2kg	CBRT02	6
20kg	CBRT20	N/A



## SPA CHLOR

Spa Chlor is an effective and convenient sanitiser to prevent growth of bacteria and algae in your spa pool.

SIZES	CODE	CARTON QTY
1kg	CSPC01	6
2kg	CSPC02	6



## SPA SHOC SHOT

Spa Shoc Shot automatically chlorinates the water without the need for daily dosing. Ideal for small tablet dispensers for spa pools.

SIZES	CODE	CARTON QTY
1KG	CPSP01	6



## **SPA BRILLIANCE**

Used as a regular or shock treatment in spas and hot tubs. Contains buffering agents that assists in stabilising water pH levels, Sodium Tetraborate for water softness and floc to clarify water.

**SIZES**

1L

**CODE**

**CSPSG01**

**CARTON QTY**

6



# SPECIALTY PRODUCTS



Specialty products are the icing on the cake when it comes to pool & spa care. This range includes shocks, water enhancers, clarifiers and additives that enhance the quality of your pool and spa water and create a better swimming experience.





## O2 SHOCK

O2 Shock is a non-chlorine shock treatment especially formulated for spas and pools. It will remove odours and oxidise organic contaminants with an effervescent water clearing (works in partnership with Crystal Water H2OK).

SIZES	CODE	CARTON QTY
1kg	CO2S01	6



## H2OK

H2OK is a non-chlorine treatment for spas and pools that is best when working in conjunction with Crystal Water O2 Shock.

SIZES	CODE	CARTON QTY
1L	CH2O01	6
5L	CH2O05	4



## PURE ENZYMES FOR SPAS

Water's Choice Pure Enzymes for Spas is a natural enzyme sanitiser that can be used as a natural additive to reduce the use of chemical-based sanitisers.

SIZES	CODE	CARTON QTY
354ml	SPENZWC12	12



## ANTI CHLOR

Anti Chlor (Sodium Thiosulphate) is a chlorine neutraliser that lowers chlorine and bromine levels in pools and spas.

### SIZES

5kg  
25kg

### CODE

ANC05  
ANC25

### CARTON QTY

4  
1



## STARVER

Starver removes phosphate from the water.

### SIZES

1L  
5L

### CODE

CSTARVER01  
CSTARVER05

### CARTON QTY

6  
4



## SINGLE SHOT POOL CLARIFIER

Single Shot Clarifier removes fine particles that cannot be caught by filtration alone and clarifies dull water. Just pop them in your skimmer basket and away you go!

### SIZES

125kg

### CODE

CWSKT125

### CARTON QTY

20



## LIQUA FLOC

Liqua Flocc is a concentrated flocculent that clears the cloudiest pools by dropping coagulated debris to pool floor for easy vacuuming.

### SIZES

1L  
5L

### CODE

LIF01  
LIF05

### CARTON QTY

6  
4



## ALUM FLOC

Alum Flocc (Aluminium Sulphate) is used to clear cloudy or discoloured water containing iron or dirt particles in suspension.

### SIZES

2kg  
5kg  
25kg

### CODE

CFLA02  
CFLA05  
FLA25

### CARTON QTY

6  
4  
1



## CRYSTAL CLEAR

Crystal Clear is a non-toxic, non-irritating solution that removes finely suspended particles that the filter cannot normally clean which causes cloudy and murky water.

### SIZES

1L  
5L

### CODE

CCRC01  
CCRC05

### CARTON QTY

6  
4



## **NO FOAM**

Used to combat any foaming problems in spa pools

### **SIZES**

1L

### **CODE**

NOF01

### **CARTON QTY**

6



## **FILTER CLEANER**

Pool and Spa Filter Cleaner is a concentrated cleaner to remove dirt, oil, body fat, grease and film from all types of filters.

### **SIZES**

1L

5L

### **CODE**

PSF01

PSF05

### **CARTON QTY**

6

4



## **SALTE CELL CLEANER**

Cleans scale build up in salt water pool cells. Can also be used to clean concrete and tile pool surface.

### **SIZES**

1L

### **CODE**

SCC01

### **CARTON QTY**

6

POOL & SPA CHEMICALS  
SPECIALTY PRODUCTS



### STAIN & SCALE CONTROL

Stain And Scale Control reduces the formulation of stain and scale in pools.

SIZES	CODE	CARTON QTY
1L	SSC01	6
5L	SSC05	4



### PIPE CLEANER

Removes oils, grease and other contaminants from pipe systems and cartridges in spas.

SIZES	CODE	CARTON QTY
500ml	PPC0.5	6



### SPA & POOL FILTER CLEANER: READY TO USE

Ready to use formulation in a trigger pack. Loosens and breaks down debris.

- Extends the life of cartridge filter
- Improves filter efficiency
- Pool water is cleaner, clearer, safer, requiring less sanitation
- Assists stabilising pH
- Saves time and money

SIZES	CODE	CARTON QTY
500ml	PSFRTU	6



### POOL & SPA STAIN & SCALE REMOVER: READY TO USE

Ready to use formulation in a trigger pack. Dissolves unsightly build-up around waterline, pathways and equipment.

- Removes buildup of pathogens, algae and mould
- Makes water safer for swimming
- Easier to maintain
- Save time and money

SIZES	CODE	CARTON QTY
500ml	SSCRTU	6





**WE SELL MINERAL SALTS TO ENHANCE YOUR SWIMMING EXPERIENCE!**

Space Industries Crystal Water is now offering mineral salts in 5kg tubs. Feel free to contact your account manager or call us on **(09) 262 3902** . Alternatively, you can email us on **reception@spaceindustries.co.nz** .



**WATER'S CHOICE AROMATHERAPY SPA SALTS**

Therapeutic mineral salts to add in your spa pool and enhance your spa experience! SPENZWCASMIX2 comes with a mix of 6 different fragrances (Exotic Nights, Happy, Refresh, Summer Breeze, Tranquility & Wellness). (570 gm tub).

**SCENTS**  
MIX2

**CODE**  
SPENZWCASEMIX2

**CARTON QTY**  
6



**WATER'S CHOICE SPA SALTS SAMPLE PACK SPENZWCSPASALTS**

Ctn Qty: 12

Can't decide on one scent? Try all 5 scents in one pack!

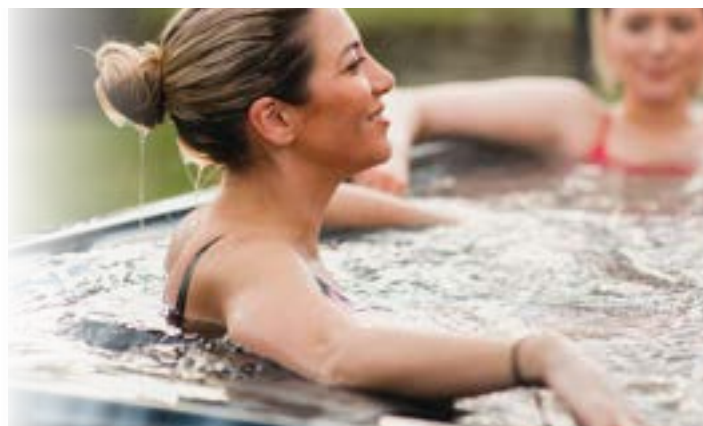

# WATER TESTING



# WATER TESTING

**MADE EASY WITH  
OUR CRYSTAL WATER ONLINE  
TOOL & AQUACHEK ©  
TEST STRIPS.**

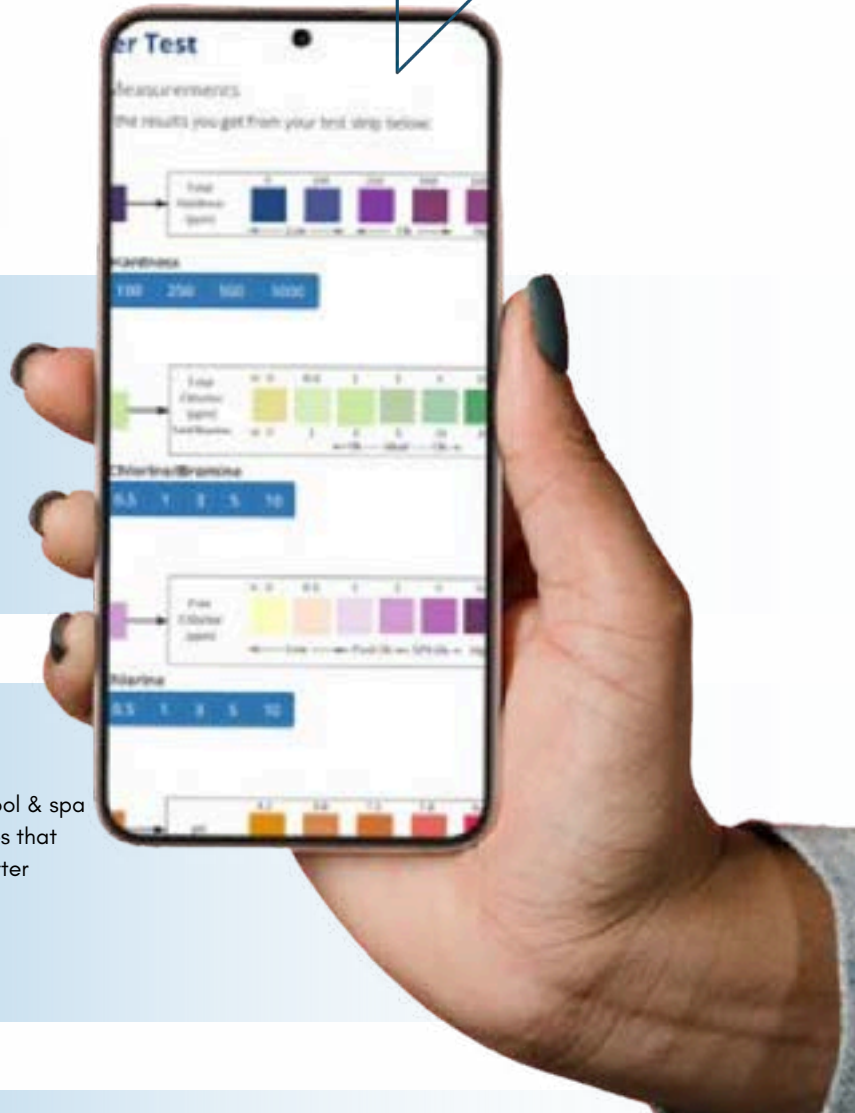

## STEP 1:

Specialty products are the icing on the cake when it comes to pool & spa care. This range includes water enhancers, clarifiers and additives that enhance the quality of your pool and spa water and create a better swimming experience.

## STEP 2:

Specialty products are the icing on the cake when it comes to pool & spa care. This range includes water enhancers, clarifiers and additives that enhance the quality of your pool and spa water and create a better swimming experience.

## STEP 3:

Specialty products are the icing on the cake when it comes to pool & spa care. This range includes water enhancers, clarifiers and additives that enhance the quality of your pool and spa water and create a better swimming experience.

POOL & SPA EQUIPMENT  
WATER TESTING



**AQUACHEK GOLD**      **SKU: AQG**

Tests for Total Chlorine, Bromine, Free Chlorine, pH, Total Alkalinity, Total Hardness, Cyanuric Acid and pH.  
**50 TEST STRIPS.**

**CTN QTY: 6**



**AQUACHEK GOLD**      **SKU: AQGR**  
**REFILL KIT**

Refill kit for the AquaChek Gold test strips. **50 TEST STRIPS.**

**CTN QTY: 6**



**AQUACHEK SILVER**      **SKU: AQS**

Tests for Total Chlorine, Free Chlorine, Total Bromine, Total Alkalinity, Total Hardness, Cyanuric Acid and pH.  
**100 TEST STRIPS.**

**CTN QTY: 6**



**AQUACHEK YELLOW**      **SKU: AQY12**

Tests for Total Chlorine, Total Alkalinity and pH.  
**50 TEST STRIPS.**

**CTN QTY: 12**



**AQUACHEK SPA**      **SKU: AQSPA**

Tests for Total Chlorine, Free Chlorine, Total Bromine, Total Alkalinity, Total Hardness and pH. **50 TEST STRIPS.**

**CTN QTY: 12**



**AQUACHEK SALT**      **SKU: AQW**

Tests for Sodium Chloride levels.  
**10 TEST STRIPS.**

**CTN QTY: 10**

POOL & SPA EQUIPMENT  
WATER TESTING



**AQUACHEK PEROXIDE**

Tests for Peroxide, Total Alkalinity and pH.  
**25 TEST STRIPS.**

**CTN QTY: 12**



**TEST TABLETS**

TTN1 - DPD No 1 Free Chlorine  
TTN3 - DPD No 2 Combine Chlorine  
TTCA - Cyanuric Acid  
TTR - Phenol Red  
10 TABLETS PER STRIP.

**CTN QTY: 25**



**TESTING SOLUTIONS**

TKS2-30 - Solution 2 - 30ml  
TKS4-15 - Solution 4 - 15ml  
TTCA - Cyanuric Acid  
TTN1 - Chlorine Free  
TTN3 - Chlorine Combined  
TTR - Phenol

**CTN QTY: N/A**



160 Plunket Ave, Wiri, Auckland  
(09) 262 3902  
[www.spaceindustries.co.nz](http://www.spaceindustries.co.nz)  
[reception@spaceindustries.co.nz](mailto:reception@spaceindustries.co.nz)  
v924.2